

CONTROL, DISTRIBUCION Y TRANSMISION

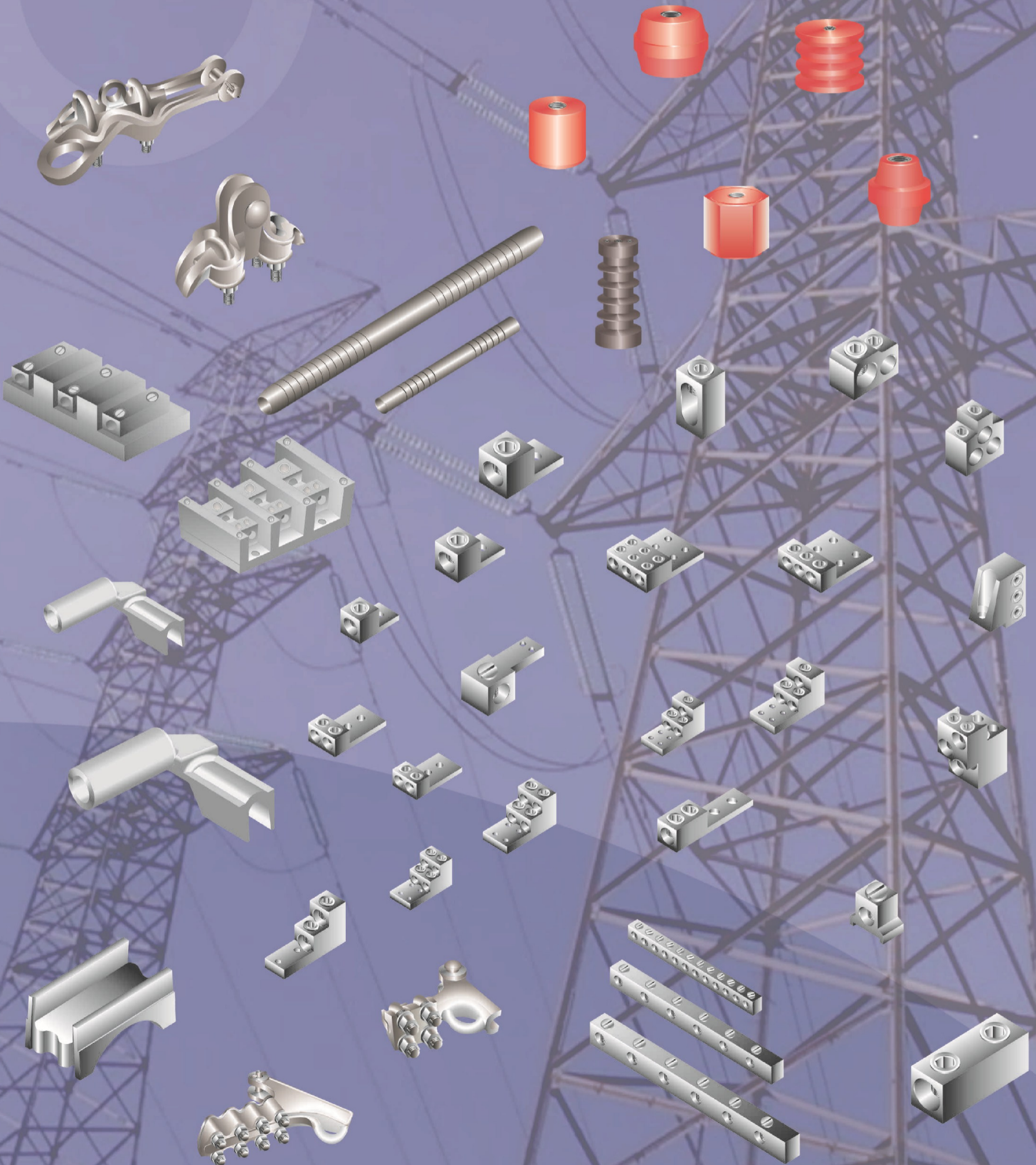

**TERMINALES ELÉCTRICAS
DE ALUMINIO 600V
PARA USAR CON CONDUCTORES
DE COBRE O ALUMINIO
DISEÑADO DE ACUERDO
A LA NORMA NMXJ-383**

**DUAL RATED SOLDERLESS
FOR USE WITH ALUMINUM
AND COPPER CONDUCTORS
DESIGNED IN ACCORDANCE
WITH STANDARDS NMXJ-383**

Instalación:
No requiere herramienta
especial, únicamente
desarmador o la llave allen.

Installation:
No special tooling required
for instalation only socket
hex head set screw

Detallado:
Avellanado para facilitar.
Inserción de conductores-

Detail:
Countersinking to facilitate
The conductor insertion.

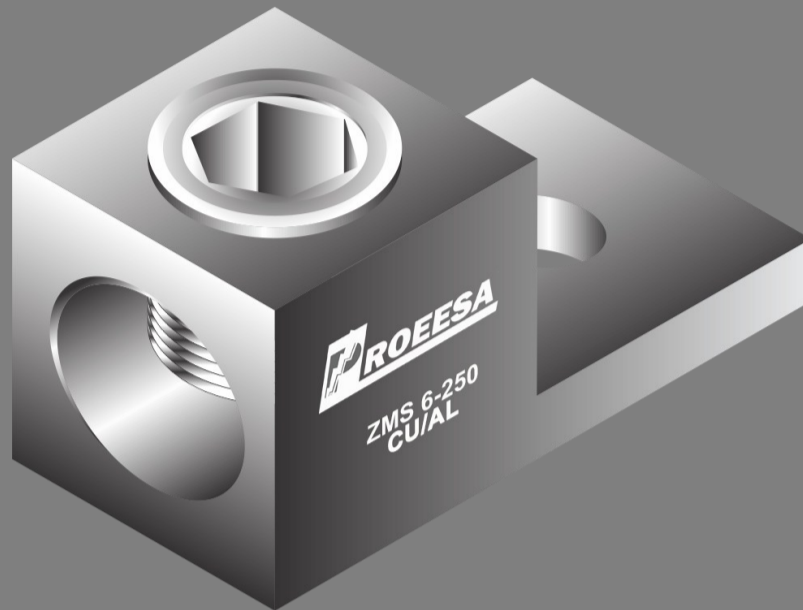

Material:
Aleaciones de aluminio
de alta conductividad y
resistencia mecánica.

Material:
High strenght and conductivity
aluminum alloy.

Acabado:
Electroestañado, para evitar
corrosión galvánica.

Finished:
Tin plated for corrosion
Resistance.

Identificación:
Marca y calibre.

Identity:
Trade mark and wire range.

ÍNDICE INDEX

LOW AND MEDIUM STRAIN

BAJA Y MEDIA TENSIÓN

INTROOUCCION INTR.ODUCTION	
TERMINALES ELECTRICAS 600V PARA UN CONDUCTOR DE "CU/AL" SINGLE HOLE SOLDERLESS WGS	2
TERMINALES ELECTRICAS 600V PARA DOS CONDUCTORES OE "CUJAL" TWO CONDUCTORS SOWERLESS WGS	3
TERMINALES ELECTRICAS 600V PARA TRES O CUATRO CONDUCTORES DE "CU/AL" THREE. FOUR CONDUCTORS SOLDERLESS WGS	4
CONECTADORES ELECTRICOS 600V DUAL RATED RECTANGULAR CONNECTOR	5
CONECTADORES ELECTRICOS 600V DUAL RATED RECTANGULAR GONNECTOR	6
CONECTADORES ELECTRICOS 600V DUAL RATED RECTANGULAR CONNECTOR	7
BARRASNEUTRAS NEUTRAL BARS	8
PORTAFUSIBLES FUSE HOLDER	9
AISLADORES ELECTRICOS TIPO SOPORTE ELECTRICAL STANDOFF INSULATORS	10
AISLADORES ELECTRICOS TIPO SOPORTE ELECTRICAL STANDOFF INSULATORS	11

DISTRIBUTION
AND TRANSMISSION

DISTRIBUCIÓN Y TRANSMISIÓN

BLOQUES DE DISTRIBUCION POWER DISTRIBUTION BLOCKS	12
CONECTADORES DERIVADOS DE ALUMNINIO TIPO "E" "E" TYPE ALUMINUM COMPRESSION TAP CONNECTORS	
CLEMA REMATE DE ALUMINIO Y HIERRO MALEABLE ALUMINUM AND MALLEEABLE IRON STRAIN CLAMP	13
CLEMA REMATE DE ALUMINIO Y HIERRODUCTL ALUMINUM AND DUCTIL IRON STRAIN CLAMP	14
CLEMA REMATE RECTA DE ALUMINIO Y HIERRO MALEABLE ALUMINUM AND MALLEABLE IRON STRAIN CLAMP	15
CLEMA SUSPENSQN DE ALUM NIO Y HIERRO DUCTIL ALUMINUM AND DUCTIL IRON SUSPENSION CLAMP	16
DADO DE ALUMINIO ALUMINUM DIE	17
EMPALMES DE COMPRESION COMPRESSION SPLICES	
TENSION MINIMA MINIMUN STRAIN	18
TENSION PARCIAL PARTIAL STRAJN	19
TENSION COMPLETA COMPLETE STRA	20

TERMINALES ELÉCTRICAS 600V

SINGLE HOLE SOLDERLESS LUGS

PARA UN CONDUCTOR DE "CU/AL"

FOR USE WITH BOTH "AL/CU" CONDUCTORS

Fabricadas con aleaciones de aluminio de alta conductividad y electroestañadas para proporcionar baja resistencia de contacto.

Are constructed from high conductivity aluminum alloy and tin plated to provide low contact resistance.

No. Catálogo Catalog No.	Capacidad de conductor Wire Range	Perno de fijación Stud Size	Altura Height	Longitud Length	Ancho Width	A	B
 ZMS 14-6 ZMS 14-2 ZMS 14-1/0 ZMS 14-2/0	14-6 1.5-16mm ²	0.250 " 6.35 mm	0.500 " 12.70 mm	1.062 " 27.00 mm	0.500 " 12.70 mm	—	0.250 " 6.35 mm
	14-2 1.5-25 mm ²	0.250 " 6.35 mm	0.562 " 14.3 mm	1.156 " 29.36 mm	0.500 " 12.70 mm	—	0.312 " 7.92 mm
	14-1/0 1.5-50 mm ²	0.250 " 6.35 mm	0.781 " 19.80 mm	1.47 " 37.34 mm	0.625 " 15.87 mm	—	0.437 " 11.09 mm
	14-2/0 1.5-50 mm ²	0.250 " 6.35 mm	0.781 " 19.80 mm	1.47 " 37.34 mm	0.625 " 15.87 mm	—	0.437 " 11.09 mm
 ZMS 6-250 ZMS 6-350 ZMS 2-600 ZMS 300-800	6-250 MCM 16-120 mm ²	0.312 " 7.92 mm	1.125 " 28.57 mm	2.000 " 50.80 mm	1.000 " 25.40 mm	—	0.468 " 11.88 mm
	6-350 MCM 16-185 mm ²	0.375 " 9.52 mm	1.125 " 28.57 mm	2.25 " 57.15 mm	1.125 " 28.57 mm	—	0.500 " 12.70 mm
	2-600 MCM 25-300 mm ²	0.375 " 9.52 mm	1.562 " 39.67 mm	3.187 " 80.95 mm	1.500 " 38.10 mm	—	0.875 " 22.22 mm
	300-800 MCM 150-400 mm ²	0.625 " 15.87 mm	1.940 " 49.28 mm	3.375 " 85.72 mm	1.750 " 44.45 mm	—	0.875 " 22.22 mm
 ZMS 6-250-2 ZMS 6-350-2N ZMS 2-600-2N ZMS 300-800-2N	6-250 MCM 16-120 mm ²	(2) 0.375 " (2) 9.52 mm	1.125 " 28.57 mm	3.000 " 76.20 mm	1.000 " 25.40 mm	1.000 " 25.40 mm	0.468 " 11.88 mm
	6-350 MCM 16-185 mm ²	(2) 0.500 " (2) 12.70 mm	1.380 " 35.0 mm	4.312 " 109.5 mm	1.125 " 28.57 mm	1.750 " 44.50 mm	0.500 " 12.70 mm
	2-600 MCM 25-300 mm ²	(2) 0.500 " (2) 12.70 mm	1.562 " 39.67 mm	4.687 " 119.04 mm	1.500 " 38.10 mm	1.750 " 44.50 mm	0.625 " 15.87 mm
	300-800 MCM 150-400 mm ²	(2) 0.500 " (2) 12.70 mm	1.940 " 49.28 mm	4.720 " 119.88 mm	1.750 " 44.45 mm	1.750 " 44.50 mm	0.625 " 15.87 mm
	2-600 MCM 25-300 mm ²	(2) 0.500 " (2) 12.70 mm	1.880 " 47.75 mm	5.500 " 139.70 mm	1.375 " 34.92 mm	1.750 " 44.45 mm	0.625 " 15.87 mm
 ZMSS 2-600-2N ZMSS 300-800-2N	300-800 150-400 mm ²	(2) 0.500 " (2) 12.70 mm	1.880 " 47.75 mm	6.187 " 157.15 mm	1.750 " 44.45 mm	1.750 " 44.45 mm	0.625 " 15.87 mm
	14-1 1.5-40 mm ²	0.187 " 4.75 mm	0.625 " 15.87 mm	1.156 " 29.36 mm	0.526 " 13.36 mm	—	0.257 " 6.53 mm
 ZMSLI 14-1 ZMSLI 1/0-250	1/0-250 MCM 50-120 mm ²	(2) 0.187 " (2) 4.76 mm	1.000 " 25.40 mm	2.250 " 57.15 mm	1.000 " 25.4 mm	0.375 " 9.50 mm	0.375 " 9.50 mm

* DIMENSIONES ESPECIALES POR REQUERIMIENTO

* SPECIAL DIMENSIONS PER CUSTOMER REQUIREMENTS

TERMINALES ELÉCTRICAS 600V



TWO CONDUCTORS SOLDERLESS LUGS

PARA DOS CONDUCTORES DE "CU/AL"

FOR USE WITH BOTH "AL/CU" CONDUCTORS

Fabricadas con aleaciones de aluminio de alta conductividad y electroestañadas para proporcionar baja resistencia de contacto.

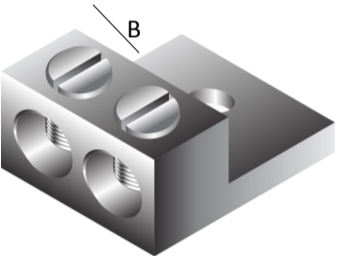
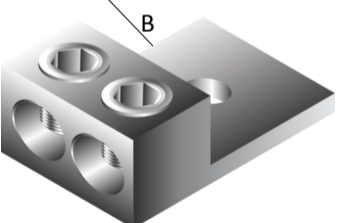
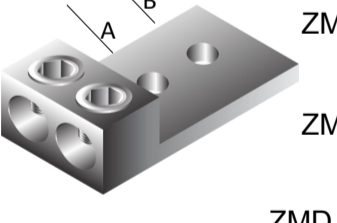
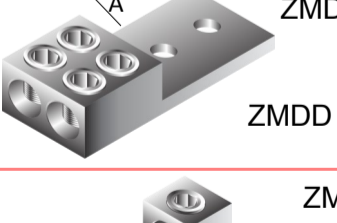
Are constructed from high conductivity aluminum alloy and tin plated to provide low contact resistance.

No. Catálogo Catalog No.	Capacidad de conductor Wire Range	Perno de fijación Stud Size	Altura Height	Longitud Length	Ancho Width	A	B
	ZMD 14-6 (2) 14-6 (2) 1.5-16 mm ²	0.250 " 6.35 mm	0.500 " 12.70 mm	1.062 " 27.00 mm	1.000 " 25.4 mm	—	0.312 " 7.92 mm
	ZMD 14-2 (2) 14-2 (2) 1.5-25 mm ²	0.250 " 6.35 mm	0.562 " 14.3 mm	1.156 " 29.36 mm	1.000 " 25.4 mm	—	0.312 " 7.92 mm
	ZMD 14-1/0 (2) 14-1/0 (2) 1.5-50 mm ²	0.250 " 6.35 mm	0.781 " 19.8 mm	1.47 " 37.34 mm	1.125 " 28.57 mm	—	0.437 " 11.09 mm
	ZMD 14-2/0 (2) 14-2/0 (2) 1.5-50 mm ²	0.250 " 6.35 mm	0.781 " 19.8 mm	1.47 " 37.34 mm	1.250 " 31.75 mm	—	0.421 " 10.69 mm
	ZMD 6-250 (2) 6-250 MCM (2) 16-120 mm ²	0.375 " 9.52 mm	1.125 " 28.57 mm	2.562 " 65.07 mm	1.656 " 42.06 mm	—	0.875 " 22.22 mm
	ZMD 6-350 (2) 6-350 MCM (2) 16-185 mm ²	0.500 " 12.70 mm	1.125 " 28.57 mm	2.875 " 73.02 mm	1.890 " 48.00 mm	—	0.875 " 22.22 mm
	ZMD 2-600 (2) 2-600 MCM (2) 25-300 mm ²	0.500 " 12.70 mm	1.562 " 39.67 mm	3.187 " 80.94 mm	2.406 " 61.11 mm	—	0.625 " 15.87 mm
	ZMD 300-800 (2) 300-800 MCM (2) 150-400 mm ²	0.625 " 15.87 mm	1.940 " 49.28 mm	3.375 " 85.72 mm	3.187 " 80.94 mm	—	0.875 " 22.22 mm
	ZMD 6-350-2N (2) 6-350 MCM (2) 16-185 mm ²	(2) 0.500 " (2) 12.70 mm	1.380 " 35.05 mm	4.312 " 109.52 mm	2.000 " 50.80 mm	1.750 " 44.45 mm	0.625 " 15.87 mm
	ZMD 2-600-2N (2) 2-600 MCM (2) 25-300 mm ²	(2) 0.500 " (2) 12.70 mm	1.562 " 39.67 mm	4.687 " 119.04 mm	2.406 " 61.11 mm	1.750 " 44.45 mm	0.625 " 15.87 mm
	ZMD 300-800-2N (2) 300-800 MCM (2) 150-400 mm ²	(2) 0.500 " (2) 12.70 mm	1.940 " 49.28 mm	4.720 " 119.88 mm	3.187 " 80.94 mm	1.750 " 44.45 mm	0.625 " 15.87 mm
	ZMDD 2-600-2N (2) 2-600 MCM (2) 25-300 mm ²	(4) 0.500 " (4) 12.70 mm	1.880 " 47.75 mm	5.500 " 139.70 mm	2.406 " 61.11 mm	1.750 " 44.45 mm	0.625 " 15.87 mm
	ZMDD 300-800-2N (2) 300-800 MCM (2) 150-400 mm ²	(4) 0.500 " (4) 12.70 mm	1.880 " 47.75 mm	6.187 " 157.15 mm	3.000 " 76.20 mm	1.750 " 44.45 mm	0.625 " 15.87 mm
	ZMDE 2-600-2 (2) 2-600 MCM (2) 25-300 mm ²	(2) 0.375 " (2) 9.52 mm	3.000 " 76.2 mm	4.906 " 124.61 mm	1.500 " 38.1 mm	1.375 " 34.92 mm	0.375 " 9.52 mm
	ZMDE 2-750-2 (2) 1/0-750 MCM (2) 50-300 mm ²	(2) 0.375 " (2) 9.52 mm	3.000 " 76.2 mm	4.906 " 124.61 mm	1.562 " 39.67 mm	1.375 " 34.92 mm	0.375 " 9.52 mm

* DIMENSIONES ESPECIALES POR REQUERIMIENTO

* SPECIAL DIMENSIONS PER CUSTOMER REQUIREMENTS

TERMINALES ELÉCTRICAS 600V





THREE, FOUR CONDUCTOR SOLDERLESS LUGS

**PARA TRES O CUATRO CONDUCTORES
DE "CU/AL"**

FOR USE WITH BOTH "AL/CU" CONDUCTORS

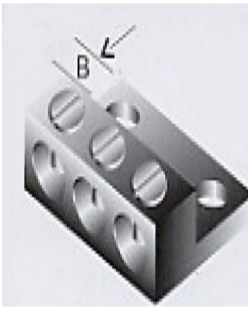
Fabricadas con aleaciones de aluminio de alta conductividad y electroestañadas para proporcionar baja resistencia de contacto.

Made of high conductivity aluminum alloy and tin plated to provide low contact resistance.

No. Catálogo Catalog No.	Capacidad de conductor Wire Range	Perno de fijación Stud Size	Altura Height	Longitud Length	Ancho Width	A	B
	ZMT 14-6-2 (3) 14-6 (3) 1.5-16 mm ²	(2) 0.250" (2) 6.35 mm	0.500" 12.70 mm	1.062" 27.00 mm	1.500" 38.1 mm	—	0.312" 7.92 mm
	ZMT 14-2-2 (3) 14-2 (3) 1.5-25 mm ²	(2) 0.250" (2) 6.35 mm	0.562" 14.3 mm	1.156" 29.36 mm	1.593" 40.46 mm	—	0.312" 7.92 mm
	ZMT 14-1/0-2 (3) 14-1/0 (3) 1.5-50 mm ²	(2) 0.250" (2) 6.35 mm	0.781" 14.80 mm	1.468" 37.28 mm	1.937" 49.19 mm	—	0.343" 8.71 mm
	ZMT 14-2/0-2 (3) 14-2/0 (3) 1.5-50 mm ²	(2) 0.250" (2) 6.35 mm	0.781" 14.80 mm	1.468" 37.28 mm	1.937" 49.19 mm	—	0.343" 8.71 mm
	ZMT 6-250-4N (3) 6-250 MCM (3) 16-120 mm ²	(4) 0.500" (4) 12.70 mm	1.380" 35.05 mm	4.000" 101.60 mm	2.812" 71.42 mm	1.750" 44.45 mm	0.625" 15.87 mm
	ZMT 6-350-4N (3) 6-350 MCM (3) 16-185 mm ²	(4) 0.500" (4) 12.70 mm	1.380" 35.05 mm	4.312" 109.52 mm	3.000" 76.20 mm	1.750" 44.45 mm	0.625" 15.87 mm
	ZMT 2-600-4N (3) 2-600 MCM (3) 25-300 mm ²	(4) 0.500" (4) 12.70 mm	1.562" 39.67 mm	4.687" 119.04 mm	3.750" 95.25 mm	1.750" 44.45 mm	0.625" 15.87 mm
	ZMT 300-800-4N (3) 300-800 MCM (3) 150-400 mm ²	(4) 0.500" (4) 12.70 mm	1.940" 49.27 mm	4.720" 119.88 mm	4.250" 107.95 mm	1.750" 44.45 mm	0.625" 15.87 mm
	ZMTT 2-600-4N (3) 2-600 MCM (3) 25-300 mm ²	(4) 0.500" (4) 12.70 mm	1.880" 47.75 mm	5.625" 142.87 mm	3.750" 95.25 mm	1.750" 44.45 mm	0.562" 14.27 mm
	ZMTT 300-800-4N (3) 300-800 MCM (3) 150-400 mm ²	(4) 0.500" (4) 12.70 mm	1.880" 47.75 mm	6.187" 157.15 mm	4.250" 107.95 mm	1.750" 44.45 mm	0.625" 15.87 mm
	ZMTE 3-600-4 (3) 2-600 MCM (3) 25-300 mm ²	(4) 0.375" (4) 9.52 mm	3.000" 76.20 mm	4.906" 124.61 mm	2.468" 62.68 mm	1.375" 34.92 mm	0.375" 9.52 mm
	ZMT 3-750-4 (3) 1/0-750 MCM (3) 50-300 mm ²	(4) 0.375" (4) 9.52 mm	3.000" 76.20 mm	4.906" 124.61 mm	3.062" 77.77 mm	1.375" 34.92 mm	0.375" 9.52 mm
	ZMCE 4-600-4 (4) 2-600 MCM (4) 25-300 mm ²	(4) 0.375 " (4) 9.52 mm	3.000 " 76.2 mm	4.906 " 124.61 mm	2.468 " 62.68 mm	1.375 " 34.92 mm	0.375 " 9.52 mm
	ZMCE 4-750-4 (4) 1/0-750 MCM (4) 50-300 mm ²	(4) 0.375 " (4) 9.52 mm	3.000 " 76.2 mm	4.906 " 124.61 mm	3.062 " 77.77 mm	1.375 " 34.92 mm	0.375 " 9.52 mm

* DIMENSIONES ESPECIALES POR REQUERIMIENTO

* SPECIAL DIMENSIONS PER CUSTOMER REQUIREMENTS

CONECTADORES ELÉCTRICOS 600V



DUAL RECTANGULAR CONNECTOR

PARA CONDUCTORES DE "CU/AL"

FOR USE WITH BOTH "AL/CU" CONDUCTORS

Fabricadas con aleaciones de aluminio de alta conductividad y electroestañadas para proporcionar baja resistencia de contacto.

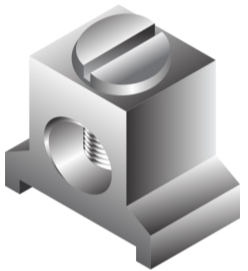
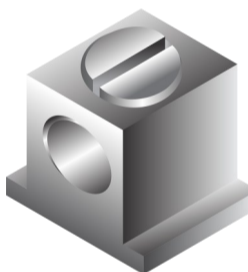
Are constructed from high conductivity aluminum alloy and tin plated to provide low contact resistance.

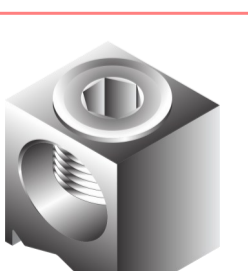
No. Catálogo Catalog No.	Capacidad de conductor Wire Range	Tipo Type	Altura Height	Profundidad Depth	Ancho Width
 CMS 14-8 W	14-8 1.5-10 mm ²	CQL-15	0.624 " 15.84 mm	0.375 " 9.52 mm	0.620 " 15.75 mm
	14-4 1.5-6 mm ²	CQL-30	0.622 " 15.80 mm	0.500 " 12.70 mm	0.620 " 15.75 mm
 CMS 14-4 E	14-4 1.5-6 mm ²	FAL-30	0.590 " 14.98 mm	0.500 " 12.70 mm	0.600 " 15.24 mm
 CMS 14-1/0 W	14-1/0 1.5-50 mm ²	CQL-100	0.800 " 20.32 mm	0.625 " 15.87 mm	0.600 " 15.24 mm
	14-1/0 1.5-50 mm ²	FAL-100	0.800 " 20.32 mm	0.625 " 15.87 mm	0.600 " 15.24 mm
 CMS 14-2/0 F	14-2/0 1.5-50 mm ²	NEF-100	0.875 " 22.22 mm	0.656 " 16.66 mm	0.656 " 16.66 mm
	6-250 MCM 16-120 mm ²	NFJ-225	1.221 " 31.00 mm	0.812 " 20.62 mm	0.812 " 20.62 mm
 CMS 4-300 E	4-300 MCM 16-185 mm ²	KAL-225	1.300 " 33.00 mm	0.875 " 22.22 mm	0.968 " 24.60 mm
	4-300 MCM 16-185 mm ²	KAL-225	1.215 " 30.86 mm	0.875 " 22.22 mm	0.968 " 24.60 mm

* DIMENSIONES ESPECIALES POR REQUERIMIENTO

* SPECIAL DIMENSIONS PER CUSTOMER REQUIREMENTS

CONECTADORES ELÉCTRICOS 600V





DUAL RATED RECTANGULAR CONNECTOR

PARA CONDUCTORES DE "CU/AL"

Fabricadas con aleaciones de aluminio de alta conductividad y electroestañadas para proporcionar baja resistencia de contacto.

FOR USE WITH BOTH "AL/CU" CONDUCTORS

Are constructed from high conductivity aluminum alloy and tin plated to provide low contact resistance.

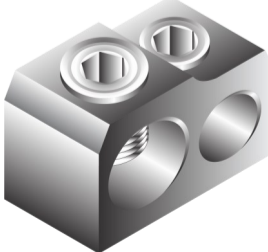
No. Catálogo Catalog No.	Capacidad de conductor Wire Range	Tipo Type	Altura Height	Profundidad Depth	Ancho Width
 CMS (2) 3/0-250 W	(2) 3/0-250 MCM (2) 70-120 mm ²	LB-400	1.906 " 48.40 mm	0.875 " 22.22 mm	1.015 " 25.78 mm
 CMS 6-350 W	6-350 MCM 16-185 mm ²	LB-225	1.500 " 38.1 mm	0.875 " 22.22 mm	1.032 " 26.21 mm
 CMS 250-500 S	250-500 MCM 120-240 mm ²	SIEMENS	2.000 " 50.8 mm	1.000 " 25.4 mm	1.500 " 38.1 mm
 CMS (2) 1/0-250 E	(2) 1/0-250 MCM (2) 16-120 mm ²	LAL-400	2.010 " 51.05 mm	1.262 " 32.05 mm	1.260 " 32.00 mm
 CMD 250-500 F	(1) 1/0-250 MCM (1) 50-120 mm ² (1) 2-500 MCM (1) 25-240 mm ²	NJL-500	1.285 " 32.64 mm	1.000 " 25.4 mm	1.750 " 44.45 mm

* DIMENSIONES ESPECIALES POR REQUERIMIENTO

* SPECIAL DIMENSIONS PER CUSTOMER REQUIREMENTS

CONECTADORES ELÉCTRICOS 600V



DUAL RATED RECTANGULAR CONNECTOR

PARA CONDUCTORES DE "CU/AL"

FOR USE WITH BOTH "AL/CU" CONDUCTORS

Fabricadas con aleaciones de aluminio de alta conductividad y electroestañadas para proporcionar baja resistencia de contacto.

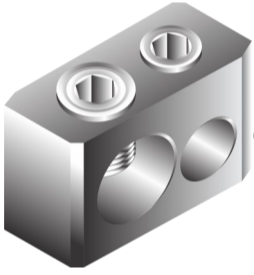
Are constructed from high conductivity aluminum alloy and tin plated to provide low contact resistance.

No. Catálogo Catalog No.	Capacidad de conductor Wire Range	Tipo Type	Altura Height	Profundidad Depth	Ancho Width
 CMD 250-500 G	(1) 1/0-250 MCM (1) 50-120 mm ² (1) 2-500 MCM (1) 25-240 mm ²	TJK THJK	1.500 " 38.1 mm	0.962 " 24.43 mm	2.000 " 50.8 mm
 CMD 3/0-400 F	(2) 3/0-400 MCM (2) 70-192 mm ²	NM-800	3.000 " 76.20 mm	2.280 " 57.91 mm	1.375 " 34.92 mm
 CMT 4/0-500 F	(3) 4/0-500 MCM (3) 95-240 mm ²	NM-1000	3.000 " 76.20 mm	2.280 " 57.91 mm	1.375 " 34.92 mm
 CMT 3/0-500 E	(3) 3/0-500 MCM (3) 70-240 mm ²	MAL-1000	2.750 " 69.85 mm	1.250 " 31.75 mm	2.304 " 58.52 mm
 CMT 3/0-400 W	3) 3/0-400 MCM (3) 70-192 mm ²	NB-800	2.500 " 63.5 mm	2.580 " 65.53 mm	1.920 " 48.76 mm
 CMC 4/0-500 W	(4) 4/0-500 MCM (4) 95-240 mm ²	NB-1200	3.500 " 88.90 mm	2.562 " 65.00 mm	1.920 " 48.76 mm

* DIMENSIONES ESPECIALES POR REQUERIMIENTO

* SPECIAL DIMENSIONS PER CUSTOMER REQUIREMENTS

BARRAS NEUTRAS 600V

CONECTORES MECÁNICOS A TOPE

NEUTRAL BARS DUAL RATED

DUAL RATED

SPLICER/REDUCER

PARA CONDUCTORES DE "CU/AL"

FOR USE WITH BOTH "AL/CU" CONDUCTORS

Fabricadas con aleaciones de aluminio de alta conductividad y electroestañadas para proporcionar baja resistencia de contacto.

Are constructed from high conductivity aluminum alloy and tin plated to provide low contact resistance.

No. Catálogo Catalog No.	Capacidad de conductor Wire Range	No. De Conex. No. of Circuit Taps	Altura Height	Longitud Length	Ancho Width
CM 404	14-6 1.5-16 mm ²	4	0.500" 12.70 mm	1.566 " 39.77 mm	0.375 " 9.52 mm
CM 406	14-6 1.5-16 mm ²	6	0.500 " 12.70 mm	2.360 " 60 mm	0.375 " 9.52 mm
CM 408	14-6 1.5-16 mm ²	8	0.500 " 12.70 mm	3.154 " 80.11 mm	0.375 " 9.52 mm
CM 410	14-6 1.5-16 mm ²	10	0.500 " 12.70 mm	3.948 " 100.28 mm	0.375 " 9.52 mm
CM 412	14-6 1.5-16 mm ²	12	0.500 " 12.70 mm	4.742 " 120.44 mm	0.375 " 9.52 mm
CM 414	14-6 1.5-16 mm ²	14	0.500 " 12.70 mm	5.536 " 140.61 mm	0.375 " 9.52 mm
CM 416	14-6 1.5-16 mm ²	16	0.500 " 12.70 mm	6.330 " 168.78 mm	0.375 " 9.52 mm
CM 418	14-6 1.5-16 mm ²	18	0.500 " 12.70 mm	7.124 " 180.95 mm	0.375 " 9.52 mm
CM 420	14-6 1.5-16 mm ²	20	0.500 " 12.70 mm	7.918 " 201.10 mm	0.375 " 9.52 mm
CM 422	14-6 1.5-16 mm ²	22	0.500 " 12.70 mm	8.712 " 221.28 mm	0.375 " 9.52 mm
CM 424	14-6 1.5-16 mm ²	24	0.500 " 12.70 mm	9.506 " 241.45 mm	0.375 " 9.52 mm
		No. Opressor No. Of Screws			
CML 14-2	14-2 1.5-25 mm ²	2	0.550 " 13.97 mm	1.380 " 35.05 mm	0.535 " 13.59 mm
CML 14-1/0	14-1/0 1.5-50 mm ²	2	0.790 " 20.06 mm	1.906 " 48.41 mm	0.600 " 15.24 mm
CML 6-4/0	6-4/0 16-95 mm ²	2	1.000 " 25.40 mm	2.312 " 58.72 mm	1.000 " 25.40 mm
CML 6-250	8-250 16-120 mm ²	4	1.000 " 25.40 mm	3.940 " 100 mm	1.000 " 25.40 mm
CML 6-350	8-350 16-185 mm ²	4	1.125 " 28.57 mm	4.190 " 106.42 mm	1.000 " 25.40 mm
CML 3/0-500	3/0-500 70-240 mm ²	4	1.562 " 39.67 mm	4.781 " 121.43 mm	1.375 " 34.92 mm
CML 250-750	250-750 120-300 mm ²	4	1.562 " 39.67 mm	6.062 " 153.97 mm	1.375 " 34.92 mm

CONECTOR AISLADO 600V

ISOLATER CONNECTOR

Para acometida a compresión pre-llenado de DELTATRON, para evitar corrosión galvánica, cubierto de polietileno para evitar la acumulación de polvo.

For DELTATRON pre-filled compression fitting, to avoid galvanic corrosion, covered with polyethylene to prevent dust accumulation.

No. Catálogo <i>Catalogo.</i>	Calibre y color del conductor Caliber and color of the driver		Dimensiones Dimensions	
	Principal Principal	Derivación Derivations	A	B
				



- **Acabado:** Acometidas
- **Acabado:** Aislado 600v para evitar contacto con humedad
- **Diseño bajo la norma** Norma NMX-J-383
 - **Material:** Aluminio recubierto con polietileno

AISLADORES ELÉCTRICOS TIPO SOPORTE

ELECTRICAL STANDOFF INSULATORS

Aisladores Soporte - servicio interno en aplicaciones para baja y media tensión, fabricados según normas IEC - 168 y DIN - 48136, modelados en poliéster reforzado con fibra de vidrio (BMC) o resina epóxica.

Standoff Insulators - Primarily intended to be used indoors. Low and half voltaje. Model in fiberglass reinforced poliéster (BMC) or epoxy resin in accordance with standards IEC - 168 and DIN 48136.

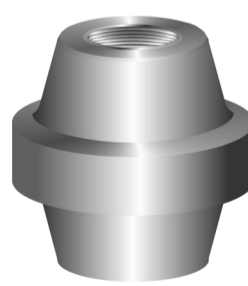
No. Catálogo Catalog No.	Voltaje de Trabajo WRated for Volt.	Resistencia a la Compresión No. of Circuit Taps	Par de Apriete Torque Strenght	Rosca Thread Size	Altura Height	
	P 100 A 11	450 V	3000 kgs.	1.65 kgs-m	0.250-20 6.35 mm-sld	1.000 " 25.4 mm
	P 100 B 11	450 V	3000 kgs.	1.65 kgs-m	0.250-20 6.35 mm-sld	1.25 " 31.75 mm
	P 100 C 12	600 V	3000 kgs.	1.65 kgs-m	0.250-20 6.35 mm-sld	2.000 " 50.80 mm
	P 200 A 11	600 V	3000 kgs.	1.65 kgs-m	0.250-20 6.35 mm-sld	1.000 " 25.4 mm
	P 200 B 11	600 V	3000 kgs.	1.65 kgs-m	0.250-20 6.35 mm-sld	1.250 " 31.75 mm
	P 300 A 22	600 V	9000 kgs.	3.45 kgs-m	0.375-16 9.52 mm-sld	1.250 " 31.75 mm
	P 500 A 11	1500 V	9000 kgs.	2.07 kgs-m	0.312-18 7.92 mm-sld	1.500 " 38.1 mm
	P 500 A 21	1500 V	9000 kgs.	3.45 kgs-m	0.375-16 9.52 mm-sld	1.500 " 38.1 mm
	P 500 B 11	2000 V	9000 kgs.	2.07 kgs-m	0.312-18 7.92 mm-sld	1.750 " 44.45 mm
	P 500 B 21	2000 V	9000 kgs.	3.45 kgs-m	0.375-16 12.70 mm-sld	1.750 " 44.45 mm
	P 500 C 22	2300 V	9000 kgs.	4.15 kgs-m	0.375-16 9.52 mm-sld	2.000 " 50.80 mm
	P 500 C 32	2300 V	9000 kgs.	6.91 kgs-m	0.500-13 12.70 mm-sld	2.000 " 50.80 mm
	P 500 D 22	2700 V	9000 kgs.	4.15 kgs-m	0.375-16 9.52 mm-sld	2.250 " 57.15 mm
	P 500 D 45	2700 V	9000 kgs.	6.91 kgs-m	0.500-13 12.70 mm-sld	2.250 " 57.15 mm

* DIMENSIONES ESPECIALES POR REQUERIMIENTO



* SPECIAL DIMENSIONS PER CUSTOMER REQUIREMENTS

AISLADORES ELÉCTRICOS TIPO SOPORTE

ELECTRICAL STANDOFF INSULATORS

Aisladores Soporte - servicio interno en aplicaciones para baja y media tensión, fabricados según normas IEC - 168 y DIN - 48136, modelados en poliéster reforzado con fibra de vidrio (BMC) o resina epóxica.

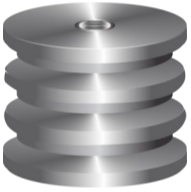
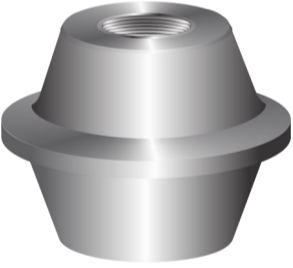
Standoff Insulators - Primarily intended to be used indoors. Low and half voltaje. Model in fiberglass reinforced poliéster (BMC) or epoxy resin in accordance with standards IEC - 168 and DIN 48136.

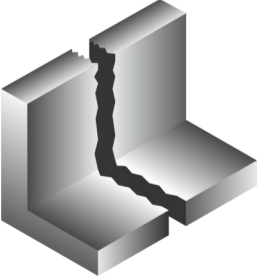
No. Catálogo Catalog No.	Voltaje de Trabajo WRated for Volt.	Resistencia a la Compresión No. of Circuit Taps	Par de Apriete Torque Strength	Rosca Thread Size	Altura Height	
	P 500 E 22	2500 V	27,200 kgs.	3,45 kgs-m	0.375-16 9.52 mm-sld	2.125 " 53.97 mm
	P 500 E 32	2500 V	27,200 kgs.	6.91 kgs-m	0.500-13 12.70 mm-sld	2.125 " 53.97 mm
	P 700 A 11	3200 V	11,300 kgs.	4.15 kgs-m	0.375-16 9.52 mm-sld	2.5 " 63.50 mm
	P 700 A 21	3200 V	11,300 kgs.	6.91 kgs-m	0.500-13 12.70 mm-sld	2.5 " 63.50 mm
	P 700 B 11	3600 V	11,300 kgs.	4.15 kgs-m	0.375-16 9.52 mm-sld	2.75 " 69.85 mm
	P 700 B 21	3600 V	11,300 kgs.	6.91 kgs-m	0.500-13 12.70 mm-sld	2.75 " 69.85 mm
	P 700 C 11	4100 V	11,300 kgs.	4.15 kgs-m	0.375-16 9.52 mm-sld	3.00 " 76.2 mm
	P 700 C 21	4100 V	11,300 kgs.	6.91 kgs-m	0.500-13 12.70 mm-sld	3.00 " 76.2 mm
	P 700 D 22	5000 V	11,300 kgs.	4.15 kgs-m	0.375-16 9.52 mm-sld	3.500 " 88.90 mm
	P 700 D 32	5000 V	11,300 kgs.	6.91 kgs-m	0.500-13 12.70 mm-sld	3.500 " 88.90 mm
		<i>Tensión Nominal/Nominal Tension</i>	<i>Resist. de Flexión/Flexion Strength</i>	<i>Rosca inferior/Lower Thread</i>	<i>Rosca superior/Higher Thread</i>	<i>Altura/Height</i>
	PEA 7.2	8.7 kv	375 kgs	0.500-13 12.70 mm-sld	0.375-16 9.52 mm-sld	4.000 " 102 mm
	PEA 17.5	15 kv	375 kgs	0.625-11 15.87 mm-sld	0.375-16 9.52 mm-sld	6.500 " 165 mm
	PEA 24	25 kv	375 kgs	0.625-11 15.87 mm-sld	0.375-16 9.52 mm-sld	8.25 " 210 mm
PEA 36	34.5 kv	375 kgs	0.625-11 15.87 mm-sld	0.375-16 9.52 mm-sld	11.81 " 300 mm	
	AFV 2X2.75X5	<i>Resistencia Dieléctrica/ Dielectric Strength</i>	<i>Resistencia a la compresión/ Tension Strength</i>	A	B	C
		14-17 kv/mm	1400-2100 kgs/cm ²	2.750 " 69.85 mm	2.000 " 50.8 mm	0.500 " 12.70 mm

* FABRICADO CON RESINA EPÓXICA

* MADE WITH EPOXY RESIN

BLOQUES DE DISTRIBUCIÓN

POWER DISTRIBUTION BLOCKS

CLASIFICADOS PARA 600V

RATED FOR 600V

Fabricadas con barra de cobre eléctrico y base de celorón. Para usar con conductores de cobre.

Made with square copper electric bar and base of celorón. For use with copper conductors.

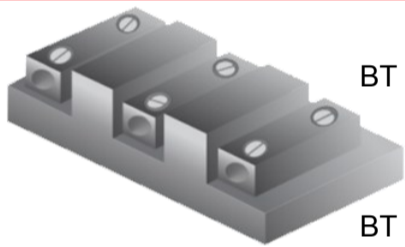
No. Catálogo Catalog No.	Capacidad en Amps. Amps. Capacity	Perno de Fijación Stud size	Altura Height	Longitud Length	Ancho Width
 BT 100 A BT 250 A	100	(4) 0.156 (4) 3.96 mm	1.400 35.56 mm	4.15 104.7 mm	2.250 57.10 mm
	250	(4) 0.156 (4) 3.96 mm	1.687 42.85 mm	5.25 133.35 mm	3.00 76.20 mm

* DIMENSIONES ESPECIALES POR REQUERIMIENTO

* SPECIAL DIMENSIONS PER CUSTOMER REQUIREMENTS

CONECTADORES DERIVADOS TIPO "L" 90°

"L" 90° TAP CONNECTORS

Conexión eléctrica y derivación en 90° de cables desnudos AL-AL, AL-ACSR y AL-CU.

Electrical connections and tap in 90° of wires AL-AL, AL-ACSR and AL-CU.

No. Catálogo Catalog No.	Descripción C.F.E. C.F.E. DESCRIPTION	Principal Main		Derivado Tap	
		Min	Max	Min	Max
 CLA2010 CLA4040	CD 9-12/4-8	9.3	12.8	4.1	8
	CD 9-12/9-12	14.9	22.4	14.9	22.4

Material: Aleación de aluminio fundido.

Material: Cast aluminum.

Acabado: Inhibidor aplicado en el interior.

Finished: Apply inhibitor.

Normas: C.F.E. 5000-85 MNX-J-170 ANCE 2002.

Rules: C.F.E. 5000-85 MNX-J-170 ANCE 2002.

GRAPA REMATE DE ALUMINIO Y HIERRO MALEABLE

ALUMINUM STRAINCLAMP

USADAS EN LÍNEAS AÉREAS DE DISTRIBUCIÓN Y TRANSMISIÓN. PARA CABLE DE ALUMINIO AAC, ACSR. Y CABLE DE COBRE FABRICADAS DE ACUERDO A LA NORMA NMX-J-383 Y ASTM A47M STANDARD NMX-J-383 AND ASTM A47M

FOR USE IN DISTRIBUTION AND TRANSMISSION AERIAL LINES. FOR ALUMINUM CABLE AAC, ACSR AND COPPER CABLE. MANUFACTURED ACCORDING TO STANDARD NMX-J-383 AND ASTM A47M

No. Catálogo Catalog No.	A	B	C	Resist. Mec. Ultimate Mechanical Strength	Torque Torsion	Pernos	U	
	CR-18 P	260	187	24	88 KN	54 Nm	12.7 Ø	4
	CR-23 P	290	215	24	102 KN	54 Nm	12.7Ø	4
	CR-34 P	370	257	43	155-KN	74 Nm	15.9 Ø	4
	CR-18 FP	225	166	19	66.7 KN	54 Nm	12.7 Ø	4
	CR-25 FP	265	200	26	89 KN	54 Nm	12.7 Ø	4
	CR-33 FP	310	240	38.1	111.3 KN	54 Nm	15.9 Ø	4

vNo. Catálogo Catalog No.	Rango Conduct. Wire Range	Perno Bolt	Material Material	Catálogo C:F:E: C:F:E: Catalog	Anderson
	CR-18 P	7.6-18.3(2-397)	Aluminio 356- T6 Aluminum 356-T6	Grapa Remate PAL 8 Strain Clamp PAL 8	Sd-70
	CR-23 P	12.1-22.5(3/0-477)	Aluminio 356- T6 Aluminum 356-T6	Grapa Remate PAL 12 Strain Clamp PAL 12	Sd-86
	CR-34 P	19.1-34(397-1.192)	Aluminio 356- T6 Aluminum 356-T6	Grapa Remate PAL 19 Strain Clamp PAL 19	Sd-130
	CR-18 FP	14-18.3(4/0-397)	Hierro Maleable Malleable Iron	Grapa Remate H 14 Strain Clamp H 14	_____
	CR-25 FP	19.5-25.3(397-636)	Hierro Maleable Malleable Iron	Grapa Remate H 19 Strain Clamp H 19	_____
	CR-33 FP	31.3-33(1033-1113)	Hierro Maleable Malleable Iron	Grapa Remate H 31 Strain Clamp H 31	_____

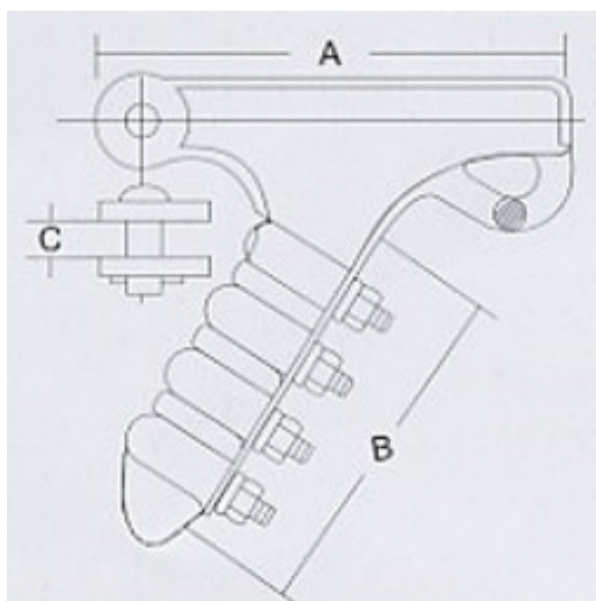

- **Acabado:** Aluminio libre de rebabas y filos. Hierro maleable galvanizado por inmersión en caliente. Norma NMX-J151
- **Finished:** Aluminum free cutting edge and rough edge. Malleable iron hot-galvanized. (Standard NMX-J151).
- **Pernos"U":** Perno, arandelas de presión y tuerca hexagonal de acero galvanizado por inmersión en caliente. Norma NMX-H-004
- **U Bolt:** Bolt, lock washer, hexagon nut of Steel hot-galvanized. (Standard NMX-H-004).
- **Chaveta** de acero inoxidable tipo "R".
- **Cotter:** of rustless Steel type "R".
- **Acotación:**mm.
- **Dimensions:** in mm.

GRAPA REMATE DE ALUMINIO Y HIERRO MALEABLE

ALUMINUM STRAINCLAMP

Usadas en líneas aéreas de distribución. Para cable de aluminio AAC, ACSR y cable de cobre. Fabricadas de acuerdo a la norma NMX-J-383 y ASTM A47M .

For use in distribution and transmission aerial lines. For aluminum cable AAC, . and copper cable. Manufactured according to Standard NMX-J-383 and ASTM A47M

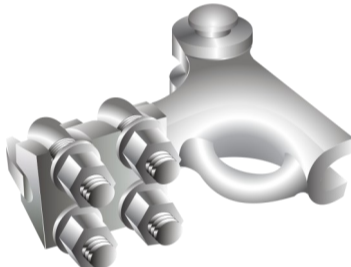
No. Catálogo Catalog No.	A	B	C	Resist. Mec. Ultimate Me- chanical Strenght	Torque Torsion	Pernos Bolts	U	
	CR-14 P	105	69	17	45 KN	54 Kn	12.7 Ø	2
	CR-22 P	182	143	27	66 KN	54 Nm	12.7 Ø	2
		Rango Conduct. Wire Range		Ø Perno Ø Bolt		Catálogo C.F.E. C.F.E. Catalog		Anderson
	CR-14 P	4.7-14.3 (6-4/0)		15.9		Grapa Remate PAL 4 Strain Clamp PAL 4		PG-46
CR-22 P	13.2-22.3(3/0-556)		15.9		Grapa Remate PAL 13 Strain Clamp PAL 13		PG-B6	

• **Acabado:** Aluminio libre de rebabas y filos. Hierro maleable galvanizado por inmersión en caliente. Norma NMX-J.151

• **Pernos "U":** Perno, arandelas de presión y tuerca hexagonal de acero galvanizado por inmersión en caliente. Norma NMX-H-004

• **Chaveta** de acero inoxidable tipo "R".

• **Acotación:** mm.

• **Finished:** Aluminum free cutting edge and rough edge. Malleable iron hot-galvanized. (Standard NMX-J-151)

• **U Bolt:** Bolt, lock washer, hexagon nut of Steel hot galvanized. (Standard NMX-H-004)

• **Cotter** of rustless Steel type "R"

• **Dimensions** in mm.

GRAPA REMATE DE ALUMINIO Y HIERRO MALEABLE

ALUMINUM STRAIGHT LINE DEAD-END STRAINCLAMP

Usadas en líneas aéreas de distribución. Para cable de aluminio AAC, ACSR y cable de cobre. Fabricadas de acuerdo a la norma NMX-J-383 y ASTM A47M .

For use in airline distribution. For ACSR or Aluminum alloy conductor and copper conductor. Manufactured in accordance with standards NMX-J-383 and ASTM A47M.

No. Catálogo Catalog No.	A	B	C	D	E	R.Mec. Ultimate Mechanical Strength	Torque Torsion	Pernos Bolts	U	
	CRR-12P	220	26	37	27	19	35.6 KN	54 Nm	12.7 Ø	2
	CRR-22P	252	26	41	28	19	44.5 KN	54 Nm	12.7 Ø	2

No. Catálogo Catalog No.	Rango Conduct. Wire Range	Ø Perno Ø Bolt	Material Material	Catálogo C.F.E. C.F.E. Catalog	Anderson
	CRR-22P	7.8-22 (2-477)	Aluminio 356 T6 Aluminum 356 T6	Grapa Remate PAL 8 Strain Clamp PAL 8	ADE-86-N
	CRR-12FP	8.1-12.5 (2-3/0)	Hierro Maleable Malleable Iron	Grapa Remate Recta FR 3 Strain Clamp FR 3	MIDE-46-N
	CRR-18FP	14-18(4/0-350)	Hierro Maleable Malleable Iron	Grapa Remate Recta FR 350 Strain Clamp FR 350	87672-2000
	CR-25 FP	19.5-25.3(450-750)	Hierro Maleable Malleable Iron	Grapa Remate Recta FR 750 Strain Clamp FR 750	—

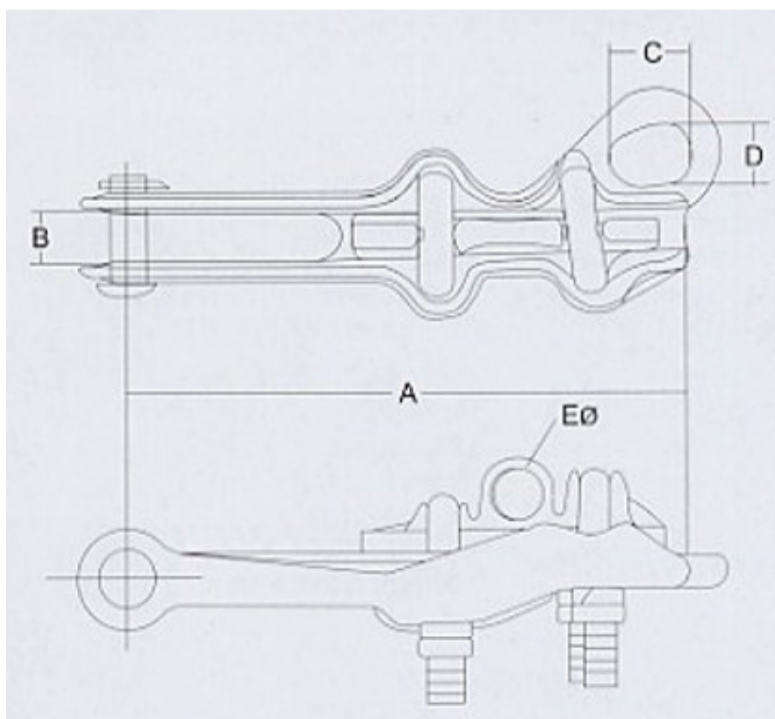

• **Acabado:** Aluminio libre de rebabas y filos. Hierro maleable galvanizado por inmersión en caliente. Norma NMX-J.151

• **Pernos "U":** Perno, arandelas de presión y tuerca hexagonal de acero galvanizado por inmersión en caliente. Norma NMX-H-004

• **Chaveta** de acero inoxidable tipo "R".

• **Acotación:** mm.

• **Finished:** Aluminum free cutting edge and rough edge. Malleable iron hot-galvanized. (Standard NMX-J-151)

• **U Bolt:** Bolt, lock washer, hexagon nut of Steel hot galvanized. (Standard NMX-H-004)

• **Cotter** of rustless Steel type "R"

• **Dimensions** in mm.

GRAPA SUSPENSIÓN DE ALUMINIO Y HIERRO DUCTIL

ALUMINUM AND DUCTILE IRON SUSPENSION CLAMP

Usadas en líneas aéreas de distribución. Para cable de aluminio AAC, ACSR y cable de cobre. Fabricadas de acuerdo a la norma NMX-J-383 y ASTM A47M .

For use in airline distribution. For ACSR or Aluminum alloy conductor and copper conductor. Manufactured in accordance with standards NMX-J-383 and ASTM A47M

No. Catálogo Catalog No.	A	B	C	D	E	R. Mec. Ultimate Mechanical Strenght	Torque Torsion	Pernos Bolts	U
CS-19 P	185	30	62	16	21	80 KN	54 Nm	12.7 Ø	2
CS-26 P	200	20	70	16	28	111 KN	54 Nm	12.7 Ø	2
CS-35 P	228	17	80	16	37	111 KN	54 Nm	12.7 Ø	2
CS-46 P	260	17	89	16	48	111 KN	54 Nm	12.7 Ø	2
CS-16 FP	149	30	56	16	17	71 KN	54 Nm	12.7 Ø	2
	Rango Conduct. Wire Range		Ø Perno Ø Bolt		Catálogo C.F.E. C.F.E. Catalog		Anderson		
CS-19 P	6.4-19.1		Aluminio 356-T6		Grapa Suspensión SAL 6		HAS-62-N		
CS-26 P	12.7-26.4		Aluminio 356-T6		Grapa Suspensión SAL 13		HAS-104-N		
CS-35 P	22.8-35.3		Aluminio 356-T6		Grapa Suspensión SAL 23		HAS-139-N		
CS-46 P	31.7-46.2		Aluminio 356-T6		Grapa Suspensión SAL 32		HAS-182-N		
CS-16 FP	5.0-11.7		Hierro Ductil		Grapa Suspensión F 71		HAS-46-N		

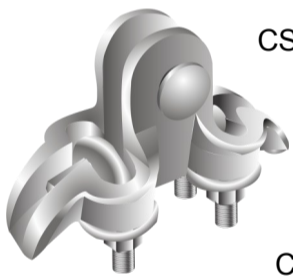

• **Acabado:** Aluminio libre de rebabas y filos. Hierro maleable galvanizado por inmersión en caliente. Norma NMX-J.151

• **Pernos "U":** Perno, arandelas de presión y tuerca hexagonal de acero galvanizado por inmersión en caliente. Norma NMX-H-004

• **Chaveta** de acero inoxidable tipo "R".

• **Acotación:** mm.

• **Finished:** Aluminum free cutting edge and rough edge. Malleable iron hot-galvanized. (Standard NMX-J-151)

• **U Bolt:** Bolt, lock washer, hexagon nut of Steel hot galvanized. (Standard NMX-H-004)

• **Cotter of rustless Steel type "R"**

• **Dimensions in mm.**

DADO DE ALUMINIO

ALUMINUM DIE

Usados para fijar a poste, crucetas: C4T, C4V y C4R. Fabricados de acuerdo a la norma: ASTMB-179 .

For use fasten lamppost, crosspiece: C4T C4V y C4R. Manufactured in accordance with standards: ASTMB-179.

No. Catálogo Catalog No.	A	B	C	D	E	F	Material Material	Catálogo C.F.E C.F.E Catalog	
	D-165 P	175	171	84	165	41	47	Aluminio Aluminum	Dado 46 RT Die 46 RT
	D-198 P	200	196	90	190	47	53	Aluminio Aluminum	Dado 47 RT Die 47 RT

• **Acabado:** Libre de rebabas y filos

• **Acotación:** mm.

• **Norma:** CFE 20100-29 DADOS RT.

• **Norma:** CFE 20000-01 Herrajes y Accesorios.

• **Masa Aproximada:** 1.600 Kg.

• **Finished:** Aluminum free cutting edge and rough edge.

• **Dimensions** in mm.

• **Standards:** CFE 20100-29 RT Die.

• **Standards:** CFE 20000-01 Ironworks and accessories.

• **Estimate Volume:** 1.600 Kg.

EMPALME DE COMPRESIÓN (TENSIÓN MÍNIMA)

COMPRESSION SPLICE

Empalmes para conductores de aluminio-aluminio o de cobre-aluminio. No son adecuados para conductores de cobre-cobre. *Connections for conductors of aluminum-aluminum or copper-aluminum. They are not suitable for copper-copper conductors.*

No. Catálogo Catalog No.	No C.F.E. C.F.E. No	Conductor ACSR Wire ACSR		Dimensiones mm Dimensions mm		Peso Aproximado K.g. Approximate Weight	
		Min	Max	A	B		
	CTM 1/0	CRU 10(1/0)	10	1/0	52	26	VC6-3
	CTM 3/0	CRU 13(3/0)	6	2/0	80	40	VC6-3
	CTM 266.8	CRU 16(266)	4	266.8	103	52	VC6-3
	CTM 336	CRU 18(336)	2/0	336.4	130	65	VC6-3
	CTM 477	CRU 22(477)	4/0	477	130	65	VC6-3

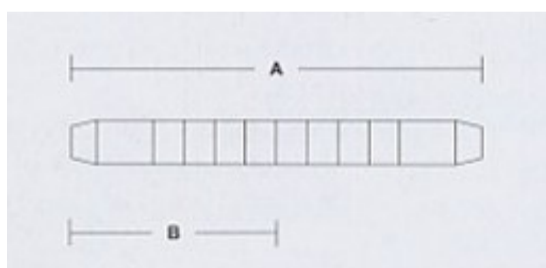

Material: Aleación de Aluminio.

Material: Aluminum alloy

Acabado: Aplicar inhibidor anti-oxidante tipo UNEC 1.

Finished: Apply inhibitor type UNEC 1.

Conductividad: 60 IACS

Conductivity: 60 IACS

PROPIEDADES MECANICAS

MECHANICAL PROPERTIES

Elongación: 25%

Elongation: 25%

Esfuerzo a la cedencia: 3,5 Ksi

Last strength: 3.5 Ksi

Esfuerzo a la tensión: 11 Ksi

Tensile strength: 11Ksi

EMPALME DE COMPRESIÓN (TENSIÓN PARCIAL)

COMPRESSION SPLICE (PARTIAL STRAIN)

Empalme de tensión parcial aleación de aluminio- Partial voltage clamping aluminum-aluminum or aluminum o de cobre-aluminio para empalmar copper-aluminum alloy to bridge conductors for puentes de conductores para tensión parcial. partial voltage.

No. Catálogo Catalog No.	Conductor ACSR Wire ACSR	LONGITUD Aluminio	Herramienta de Compresión Compression Tool	Peso Aproximado K.g. Approximate Weight
	CTP 1/0	A) 130 mm	VC6-3	0.080
	CTP 2/0	A) 160 mm	VC6-3	0.090
	CTP 4/0	A) 186 mm	VC6-3	0.100
	CTP 477	A) 200 mm	VC6-3	0.110

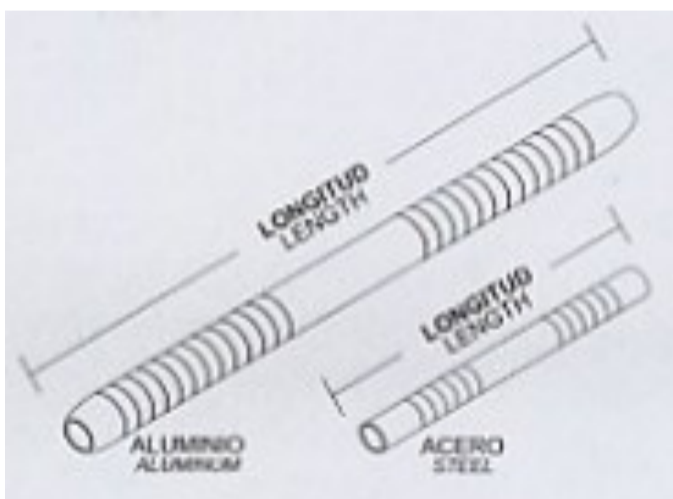

CONDUCTIVIDAD

60 IACS

PROPIEDADES

Elongación (% en 2"): 25.00

Esfuerzo a la cedencia: 3.50 Ksi

Esfuerzo a la tensión: 11 Ksi

CONDUCTIVITY

60 IACS

PROPERTIES

Elongation (% en 2"): 25.00

Last strength: 3.50 Ksi

Tensile strength: 11 Ksi

EMPALME DE COMPRESIÓN (TENSIÓN COMPLETA)

COMPRESSION SPLICE (FULL STRAIN)

Empalme de tensión completa aleación de aluminio Full voltage clamping aluminum-aluminum or cop-alumínio o de cobre-aluminio para empalmar per-aluminum alloy to bridge conductors for full voltage. puentes de conductores para tensión completa.

No. Catálogo Catalog No.	Conductor ACSR Wire ACSR	LONGITUD Aluminio	Herramienta de Compresión Compression Tool	Peso Aproximado K.g. Approximate Weight
	CTC 2/0	A) 450 mm	VC6-3	0.150
	CTC 4/0	A) 502 mm	VC6-3	0.180
	CTC 397.5	A) 552 mm	VC6-3	0.225
	CTC 477	A) 570 mm	VC6-3	0.250

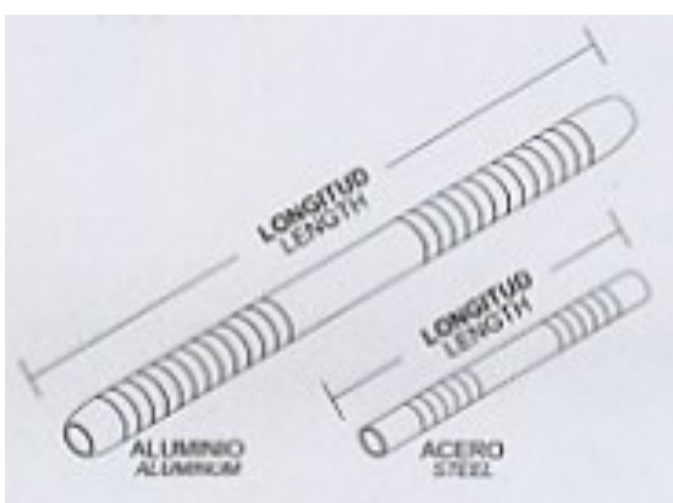

CONDUCTIVIDAD

60 IACS

PROPIEDADES

Elongación (% en 2"): 25.00

Esfuerzo a la cedencia: 3.50 Ksi

Esfuerzo a la tensión: 11 Ksi

CONDUCTIVITY

60 IACS

PROPERTIES

Elongation (% en 2"): 25.00

Last strength: 3.50 Ksi

Tensile strength: 11 Ksi

TABLAS DE VALORES DE TORSIÓN

TABLE OF TIGHTENING TORQUE

TORSIÓN DE MONTAJE PARA SUJETAR TERMINALES	
TORQUE MOUNTING FASTENER FOR TERMINALS	
TORQUE MÍNIMO PARA TORNILLOS DE CABEZA	LAST TORQUE FOR HEXAGONAL HEAD SCREW
Diametro del tornillo <i>Stud Size</i>	Torque nominal <i>Nominal Torque</i>
7.8	2.07
9.5	2.76
12.7	5.52
15.0	7.59
19.1	21.88

PARA APRETAR LOS CONDUCTORES					
FOR CONDUCTORS FASTENER					
TORSIÓN DE APRIETE PARA TERMINALES			TIGHTENING TORQUE FOR TERMINALS		
Calibre del conductor <i>Wire Ranger</i>		Desarmador <i>Screw Driver</i>		Llave Allen <i>Wrench Allen</i>	
ANG	O MCM	mm	Libras-Pulgs <i>Inch-Pounds</i>	kgs-m	Libras-Pulgs <i>Inch-Pounds</i>
14			35		
12			35	0.4	
10			35	0.4	
8		8.37	40	0.46	
6		13.3	45	0.52	
4		21.2	45	0.52	
2		42.2	50	0.57	
1/0		67.4	50	0.57	
2/0		85	50	0.57	
3/0		10.7			250 2.88
4/0		12.7			250 2.88
250		152			325 3.74
350		177			325 3.74
500		253			375 4.32
600		304			375 4.32
750		380			375 4.32
800		405			500 5.76